

99.00 EUR
incl. 19% VAT, plus [shipping](#)

CarPC JoyCon EX converts car steering wheel remote controllers into a PC USB keyboard. You can control MediaPlayer or front-ends (eg. CentraFuse) with your steering wheel audio remote controller. As the buttons of your steering wheel controller are mapped to PC keys of your choice, you will be able to control any software which can be controlled with PC keys from a keyboard.

Hardware feature

- Converts resistive steering wheel remote controls into USB HID keyboard and HID remote controller.
- Works same as standard USB HID keyboard and HID remote controller by hardware.
- 24V tolerant 4 channel resistive(voltage) input.
- Supports 28 physical buttons, 52 programmable logical buttons.
- Long and Short button for one physical button, up to 5 simultaneous key strokes by one button.
- 2 programmable LED port.
- Remote wake-up(resume PC from sleep with steering wheel remote controls).
- Channel Master/Slave selectable
- Temperature range : -40 ~ +85°C

JoyCon Explorer-aided feature

- Preset change by Preset up and down buttons.
- Speech and OSD when preset is changed, when button is pressed.
- Application link(application launches and pops up with preset changing).
- User definable Button Speech and OSD.
- Automatic Button Detection
- Rearview with USB camera
- Online firmware update.

- No external power or driver installation needs.

- Available OS : Windows 7, Vista, XP, 2003

(JoyCon Explorer supports Windows XP and the later version. JoyCon Explorer does not support Linux. But CarPC JoyCon Exr works on Linux and Mac after it is configured at Windows.)

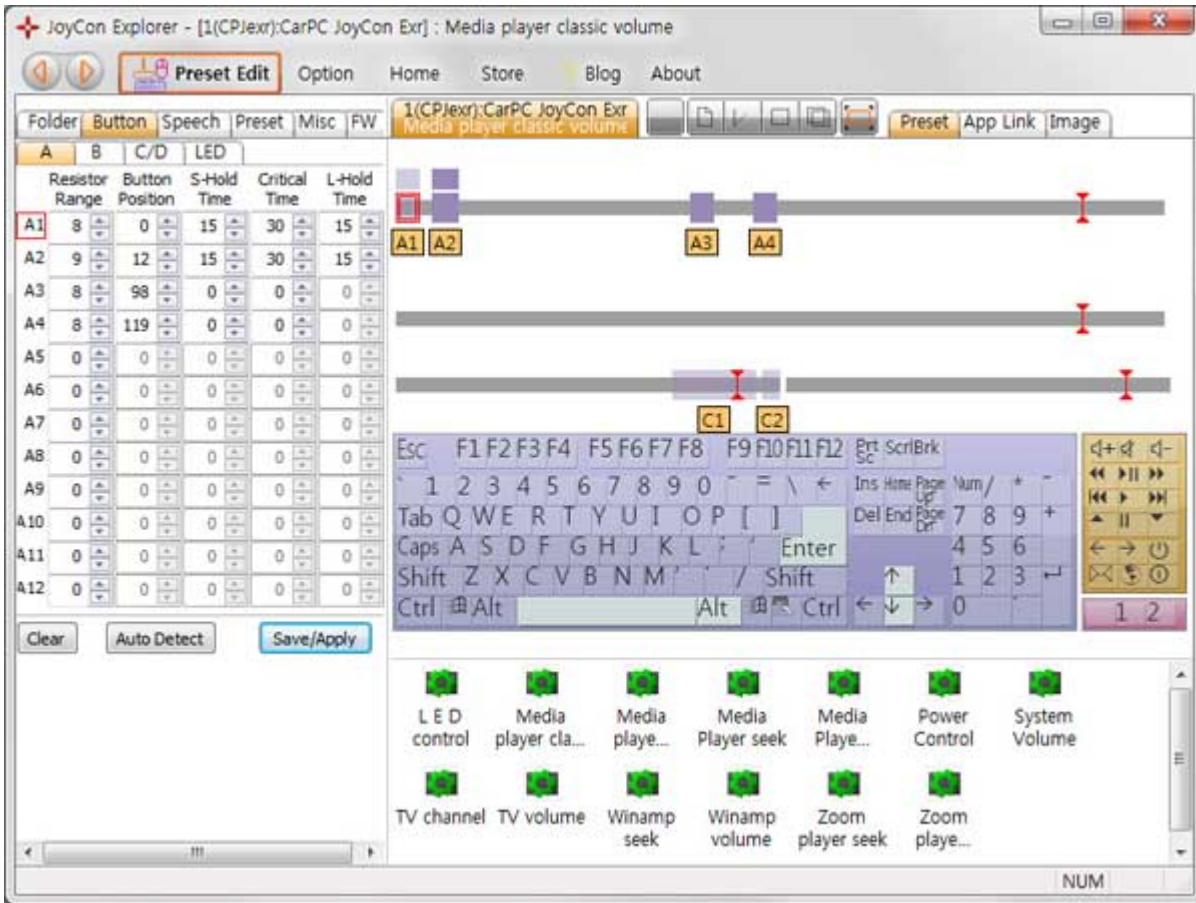

App Link enables to launch application with steering wheel remote control's button and switch application when preset is changed.

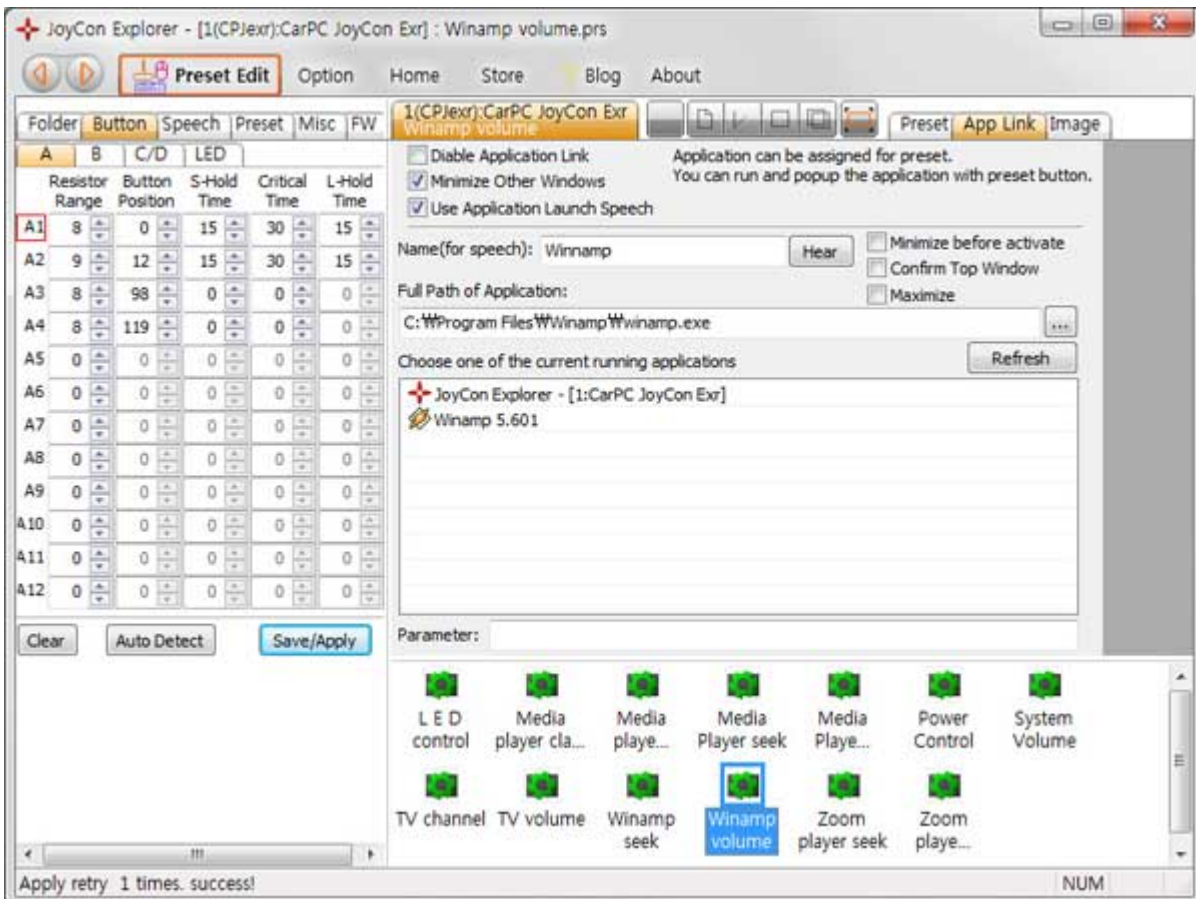

Apply retry 1 times. success!

[http://www.changjack.com/software/Jex_Setup_XP\(141013\).zip](http://www.changjack.com/software/Jex_Setup_XP(141013).zip)
[http://www.changjack.com/software/Jex_Setup_Win7_8_10\(160620\).zip](http://www.changjack.com/software/Jex_Setup_Win7_8_10(160620).zip)

Connect two wires of CarPC JoyCon Exr's input channel to the remote controls, and connect USB.

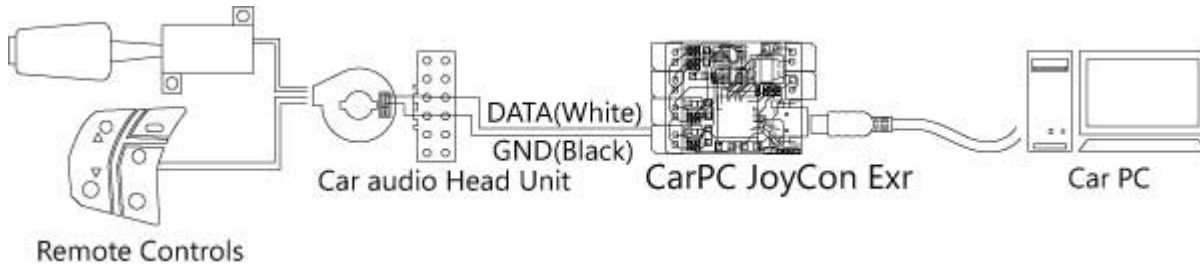

This is the typical resistance-output steering wheel remote controller's circuit.
You can put additional buttons like green box below by DIY, if you want.

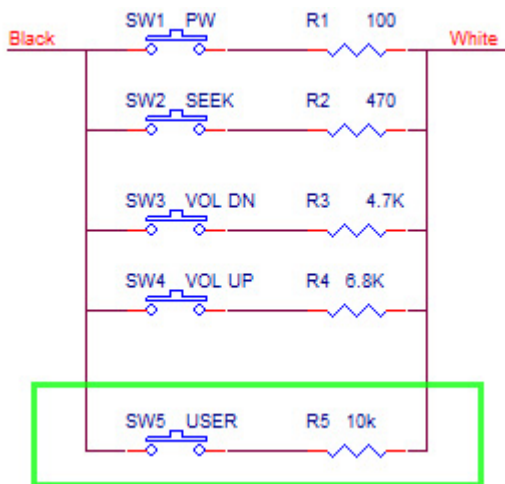

You can control two external LED.

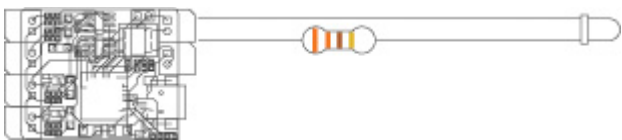

UserGuide

http://www.changjack.com/user_guide/cpjexr/CarPC_JoyCon_Exr_UserGuide_eng.pdf

You can use typical USB cam as a rearview camera with CarPC JoyCon Exr.
Any USB camera or video capture device can be rearview camera.

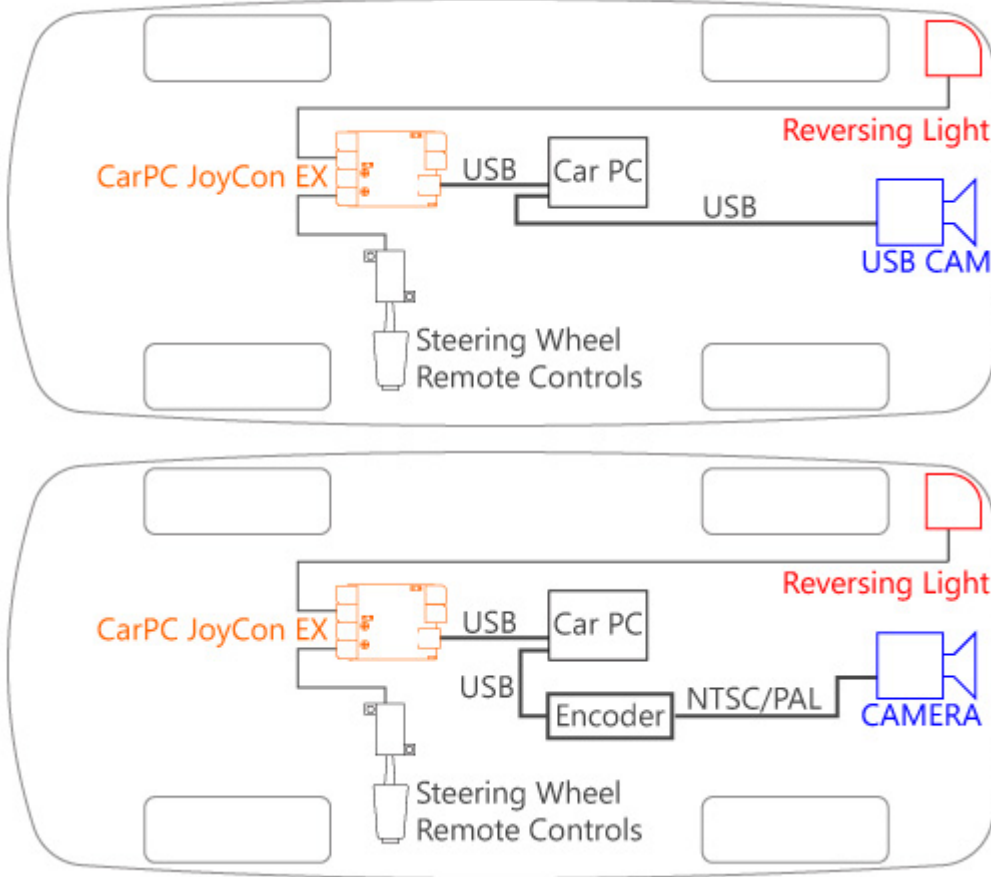

Rearview pops up when Channel C detects reversing light,

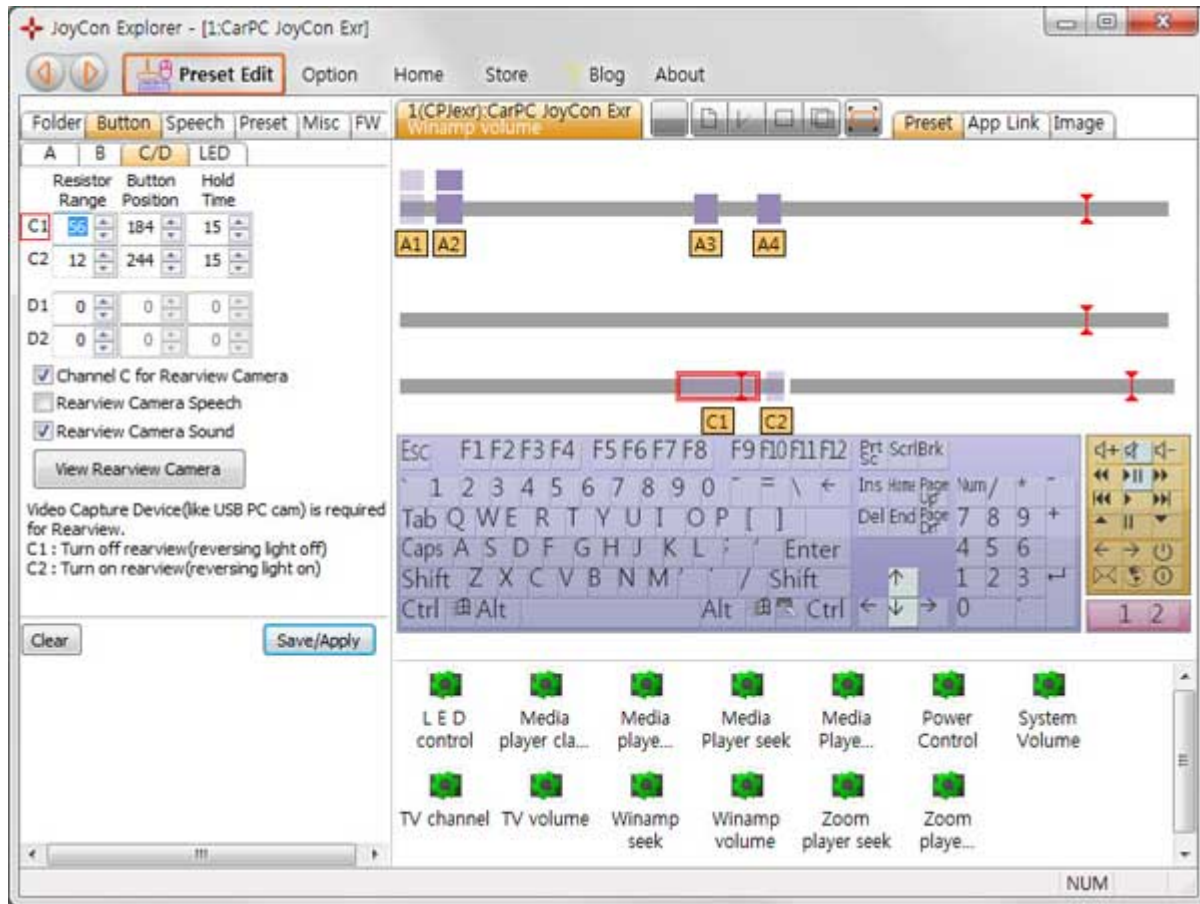

- Jex Cam shows when reversing light is detected.
- Any video capture device can be rearview camera.
- Horizontal and Vertical Mirror is supported.

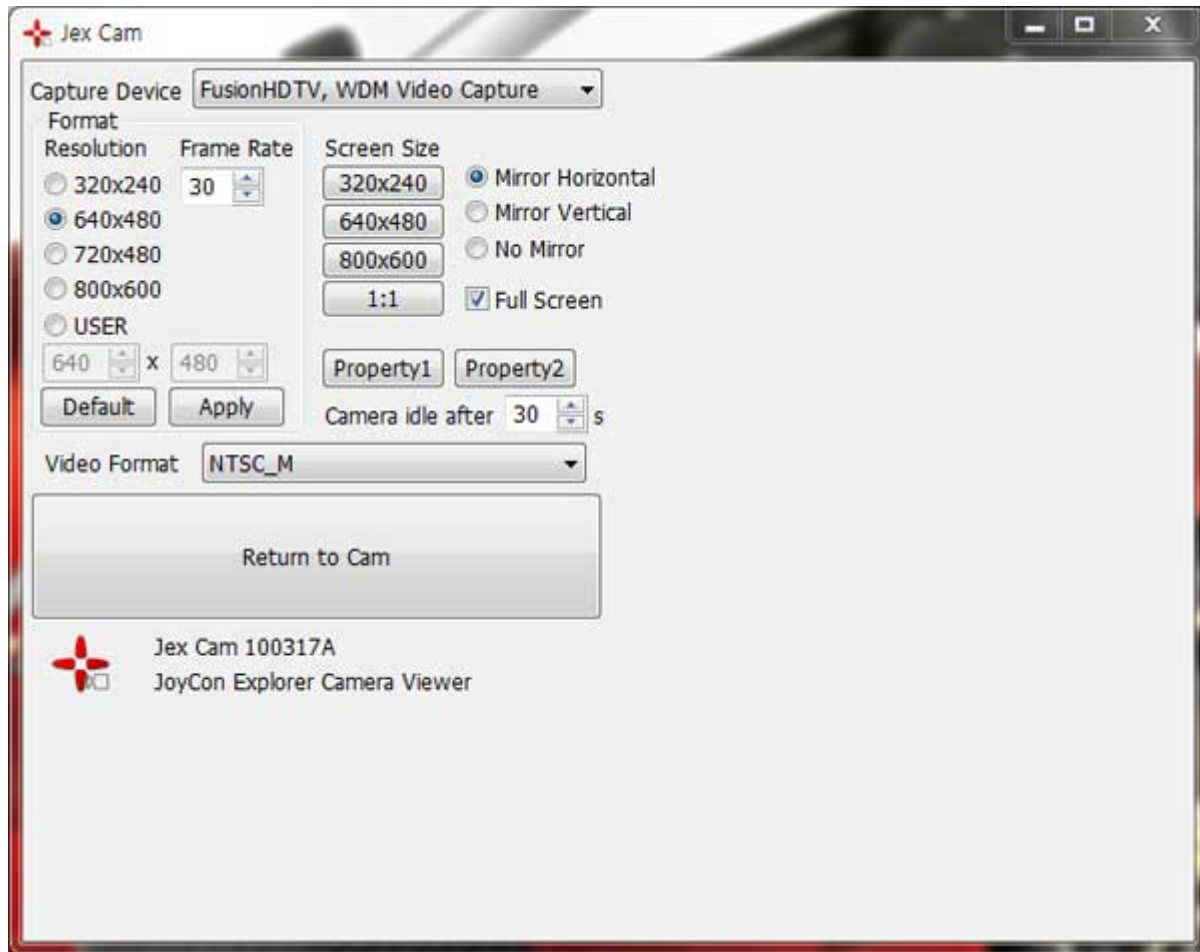

This video shows rearview test with USB camera.

[How to use Steering wheel remote controls in Centrafuse](#)

Supported cars(reported so far):

Alfa Romeo 156 2.0 JTS
Chevrolet Captiva
Chevrolet Cavalier
Citroen Xantia
Citroen XSARA 1997-2000
Dodge Durango
Fiat GrandePunto
Ford Fiesta
Ford Focus
Ford Fusion 2010
Ford Mondeo
Ford Mondeo MK2 1996-2000(Resistive PCB is required)
Ford Ranger(Cruise control only)
GM Cadillac Escalade 2002
GM Daewoo all model
Honda CRZ
Honda Ridgeline

Hyundai all model(except Sonata2/3, Marcia, Santamo)

KIA all model

Land Rover Discovery 4

Mazda3 2004-2009

Mitsubishi 380GT 2006

Nissan 350Z

Nissan Cube

Nissan Murano

Nissan Navara 2007

Peugeot 306(Resistive PCB is required)

Peugeot 806

Pontiac Firebird 96

Renault Samsung SM5/7(Audio controller only)

Rover

SAAB 9-3 9-5

Scion TC 2006

Subaru Impreza

Suzuki SX4

Toyota Camry 2005 - 2010

Toyota Corolla 2004(Cruise control only)

Toyota Corolla 2009-2010

Toyota Land Cruiser 2004

Toyota Landcruiser 200 series (2007 – 2010)

Toyota Lexus 330

Toyota supra 1990

Toyota Yaris

Vauxhall Astra G 1998-2004

Vauxhall Vectra 1999-2002

Vauxhall Vectra B 1996-2002

Vauxhall Zaffira A 1998-2005

and many other cars with resistive steering wheel controls

Supported remote controller:

Sony RM-X2S

Sony RM-X11M

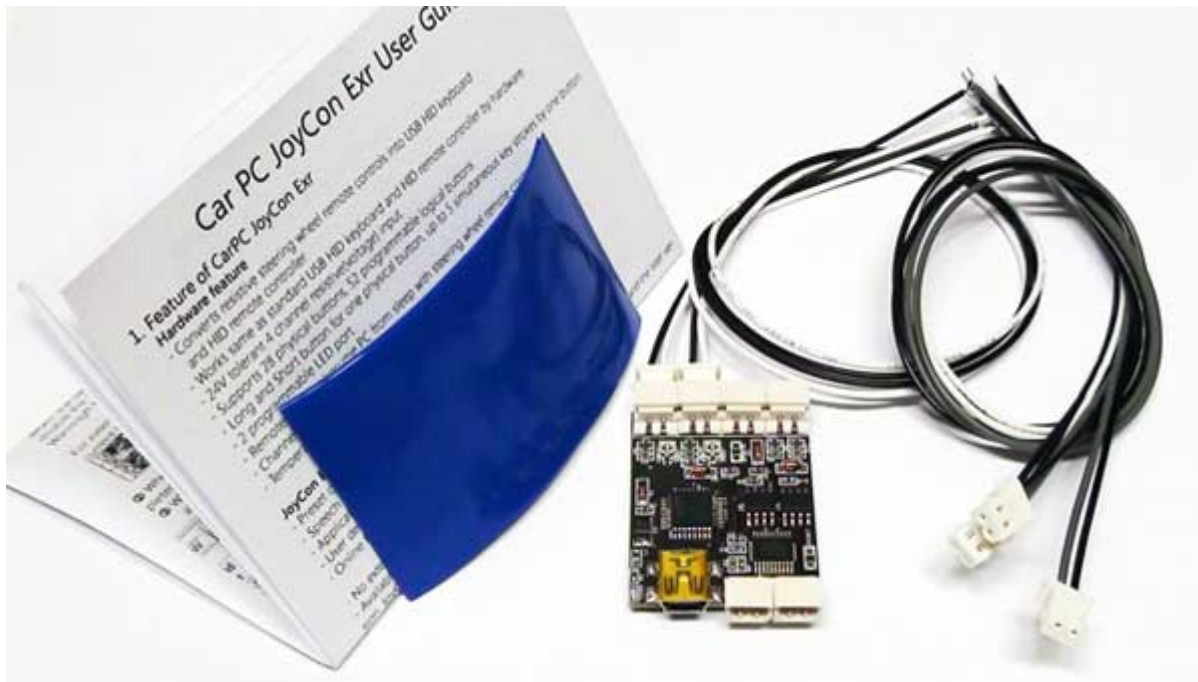

What is different Exr from Ex?

Exr is almost same with Ex.

Exr can select master/slave mode by software option(at JoyCon Explorer).

Master mode is to connect CPJexr to PC only.

Slave mode is to connect CPJexr both to PC and Car Radio.

In the previous EX version, user had to desolder the diodes on the PCB manually to use slave mode.

And Exr has an extension port for future upgrade.